

Virginia ADS Consortium – Advanced ^{233}U - ^{232}Th Breeder Burner Subcritical Micro Reactors (ASMR)

Ganapati Myneni

Virginia ADS Consortium
Director, VT-India Nuclear Energy Partnership

BSCE Systems, Inc.
Yorktown, Virginia

October 15, 2020
ORNL MSR Workshop

Weinberg – ORNL – Thorium & India

“Cheap and abundant nuclear energy is no longer a luxury; it will eventually be a necessity for maintenance of the human condition.”

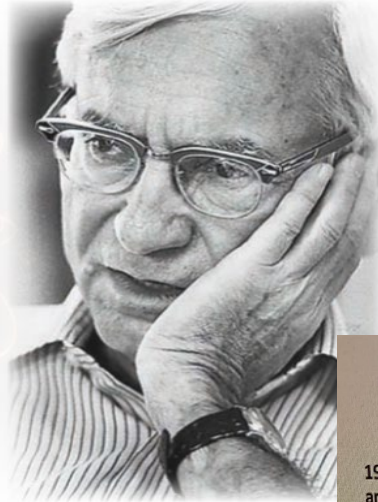

Dr Alvin Weinberg

History of the Molten Salt Reactor

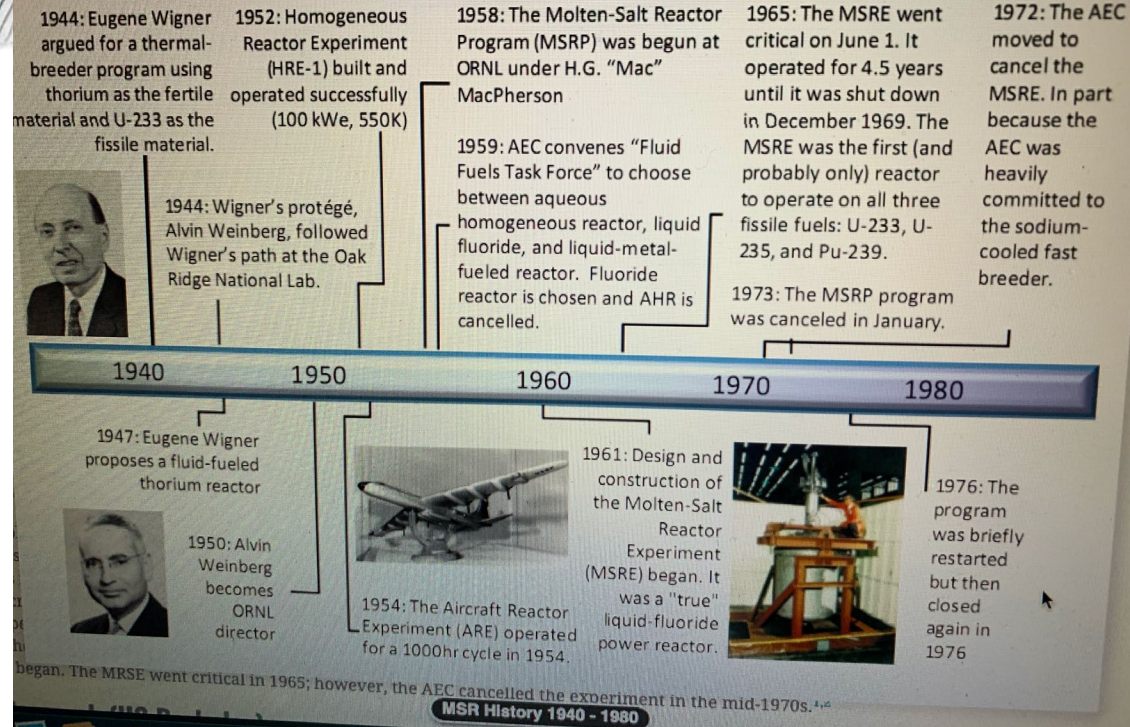

Homi Bhabha and Alvin Weinberg's Thorium Energy Vision is the future of the human development, health and survival

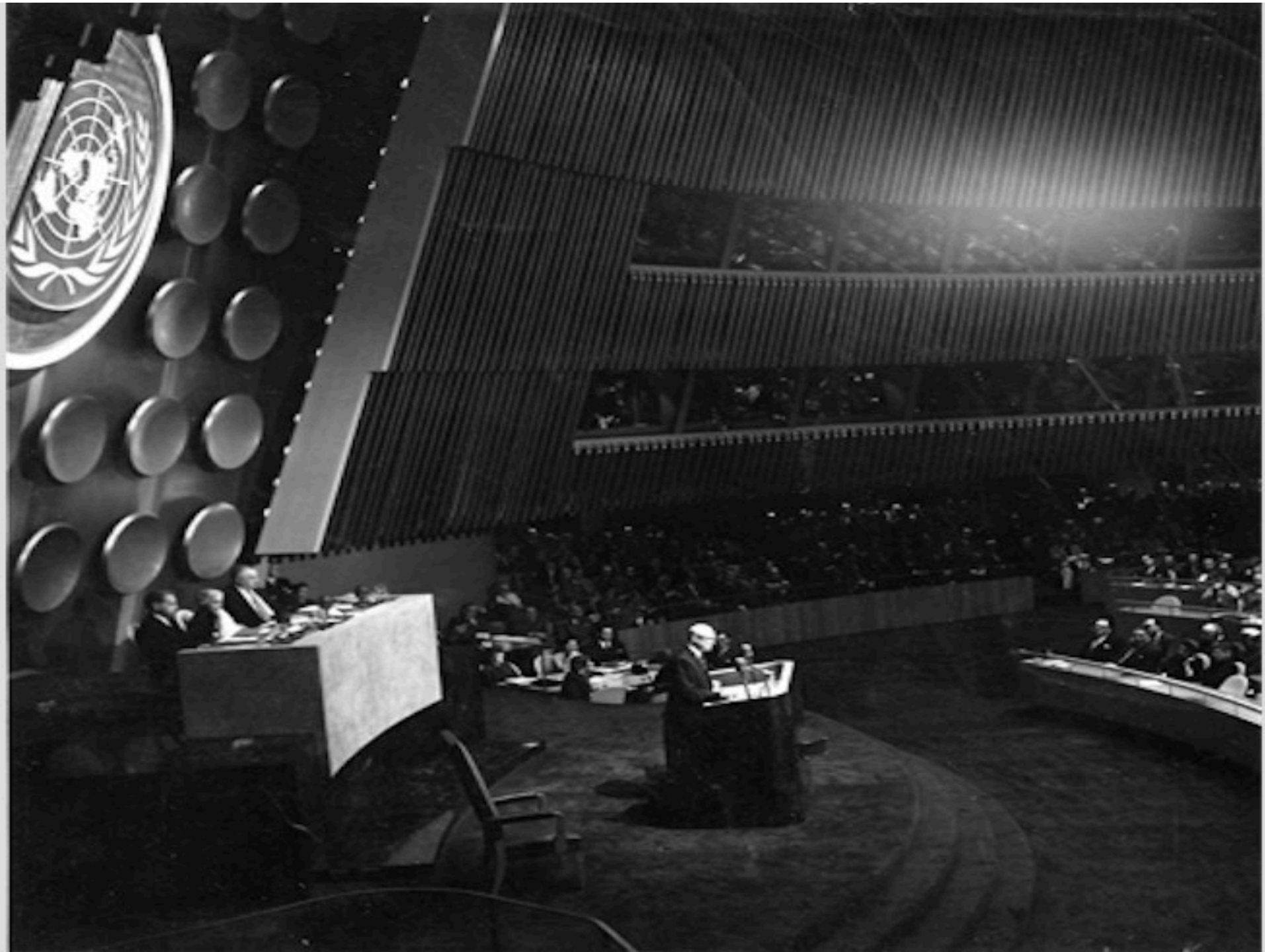



Three-Stage Indian Nuclear Programme

Thorium in the centre stage

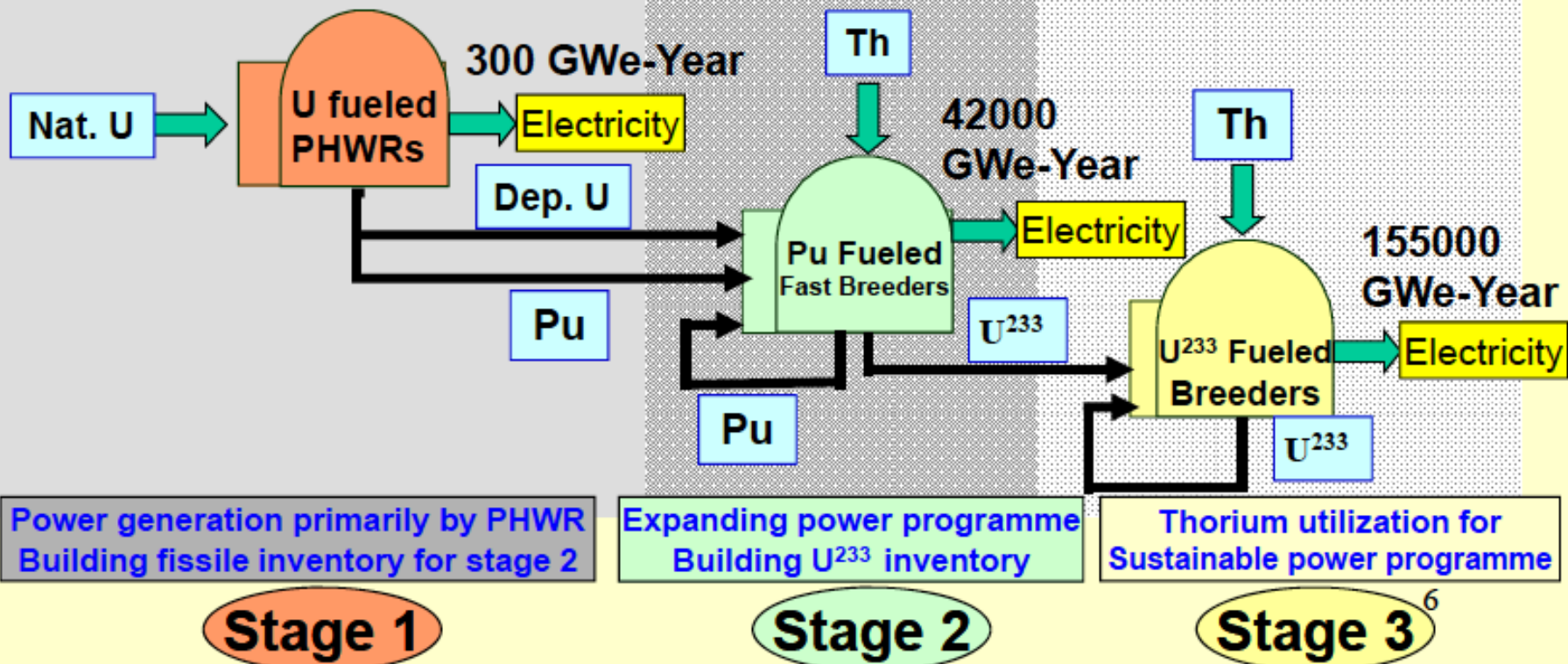
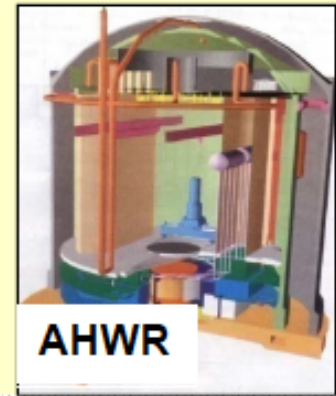
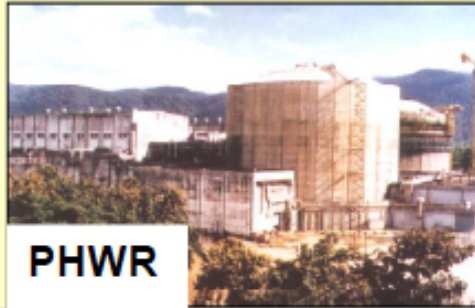

India's Thorium utilization scheme

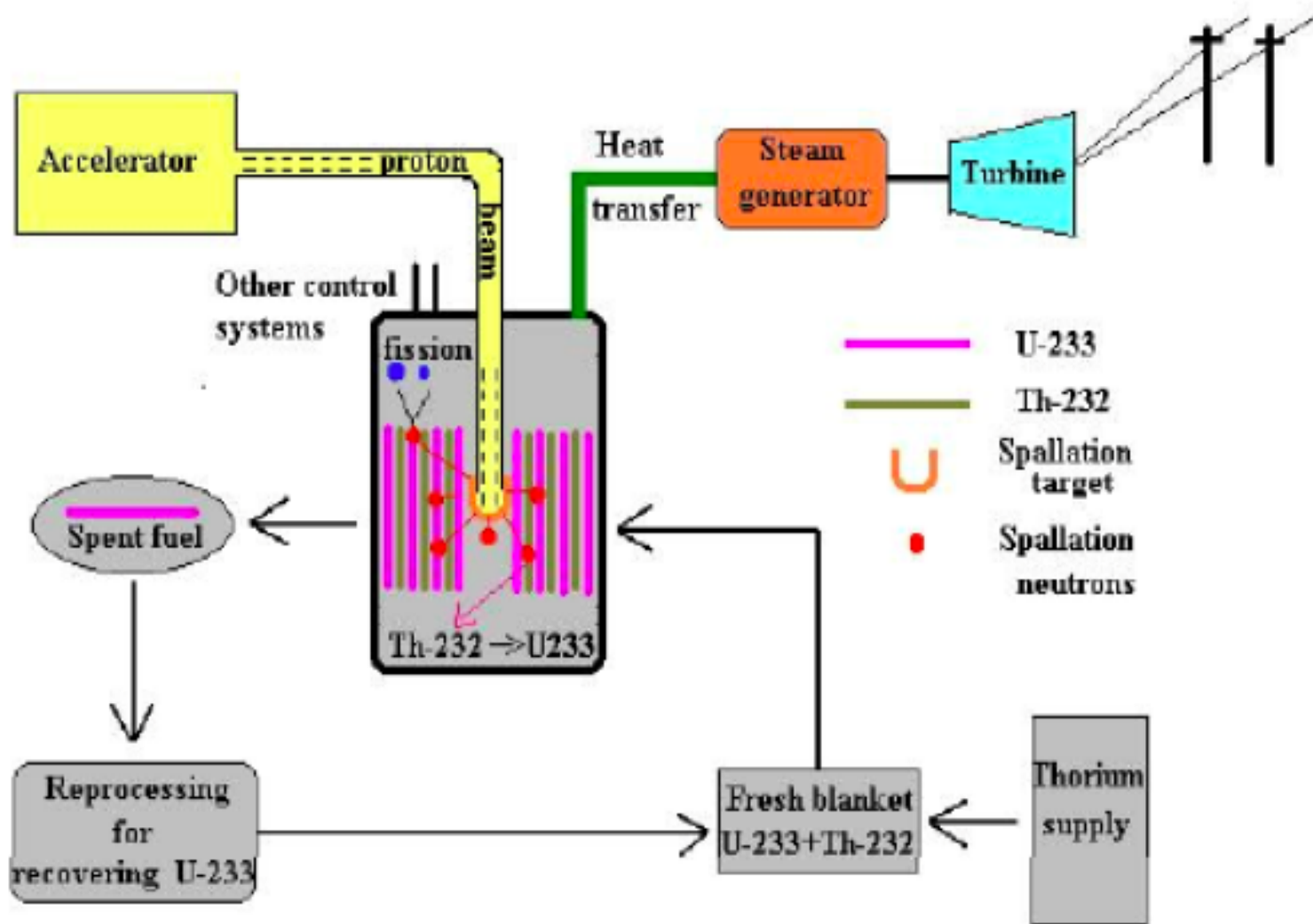

Dr. S. Banerjee, University of Virginia Presentation, May 2010

A-1. Niobium material preparation (with new processing for sheeting and piping)

International Linear Collider plan

Motivation

- Niobium material cost for fabricating SRF cavity cell and end-groups is relatively high.
- If we can accept lower residual resistivity ratio (RRR) material, the ingot cost becomes cheaper.
- We will try to simplify the manufacturing process (like direct slicing from the ingot).



Niobium ingot

US Patent 8,128,765 Large grain cavities from pure niobium ingot G. Myneni, P. Kneisel, and T. Cameiro

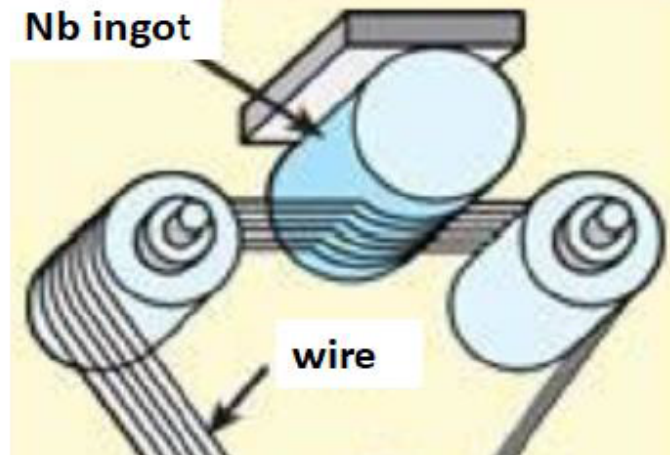

Forged ingot Nb Technology
A collaboration between
ATI, BSCE Systems, Inc. &
KEK



International Symposium On Hydrogen In Matter (ISOHIM) Publications

Hydrogen in Materials and Vacuum Systems AIP CP 671

<http://www.virtualjournals.org/dbt/dbt.jsp?KEY=APCPCS&Volume=671&Issue=1>

Hydrogen in Matter AIP CP 837

<http://www.virtualjournals.org/dbt/dbt.jsp?KEY=APCPCS&Volume=837&Issue=1>

Single Crystal Large Grain Niobium AIP CP 927

<http://www.virtualjournals.org/dbt/dbt.jsp?KEY=APCPCS&Volume=927&Issue=1>

Superconducting Science and Technology of Ingot Niobium AIP CP 1352

<http://scitation.aip.org/dbt/dbt.jsp?KEY=APCPCS&Volume=1352&Issue=1>

Science and Technology of Ingot Niobium For Superconducting Radio Frequency Applications AIP CP 1687

<https://aip.scitation.org/toc/apc/1687/1?expanded=1687>

Accelerators & fissile materials

- 1950 – U. E. O. Lawrence, high power accelerators for producing fissile materials
 - Accelerator Molten-Salt Breeders, Kazuo Furukawa et al, Energy Conversion and Management 49 (2008) 1832-1848
- 1952 – W. B. Lewis, proposed use of thorium with intense neutron generators
 - India's ADS Program with proton linac (now relegated to future)
 - BSCE Systems, Inc. ADS sub-critical micro-reactors (ASMR) with high power electron linacs

K. Furukawa's AMSB

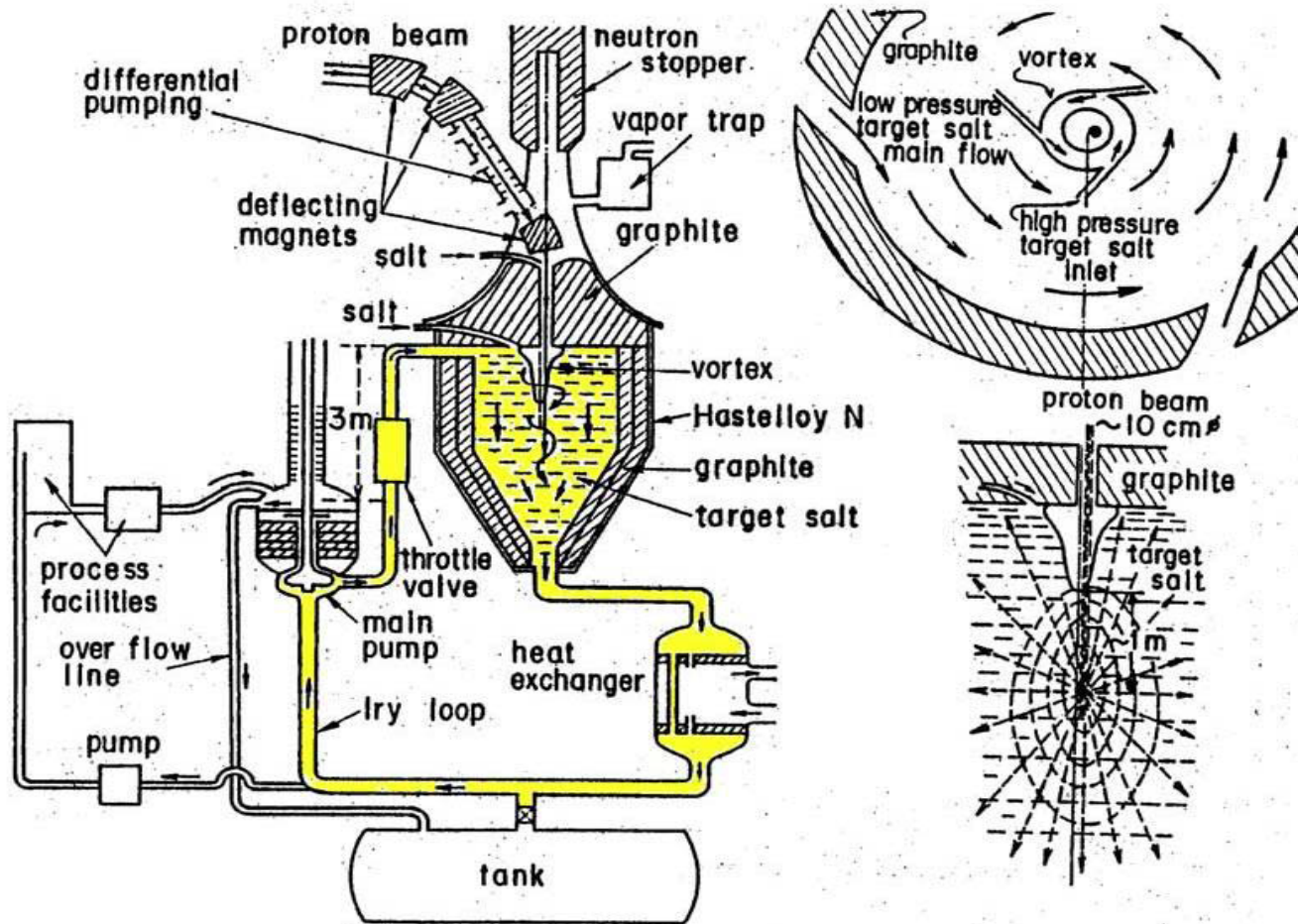

Virginia ADS Consortium Partners

- **BSCE Systems, Inc.**
- **Indian Smart Grid Forum (a PPP initiative of Govt. of India)**
- **International Symposium On Hydrogen In Matter (ISOHIM)**
- **Jefferson Lab**
- **Longwood University**
- **Oak Ridge National Laboratory**
- **Old Dominion University**
- **South Dakota School of Mines and Technology**
- **University of Virginia**
- **Virginia Commonwealth University**
- **Virginia Tech**

Accelerator Driven Systems & Thorium Utilization International Workshops

1st International ADS&ThU Workshop 2010, USA

<http://www.phys.vt.edu/~kimballton/gem-star/workshop/index.shtml>

2nd International ADS&ThU Workshop 2011, India

<http://www.ivsnet.org/ADS/ADS2011/>

3rd International ADS&ThU Workshop, 2014, USA

<http://adsthru.org/index.html>

4th International ADS&ThU Workshop 2016, UK

<https://indico.cern.ch/event/509528/contributions/>

5th International ADS&ThU Workshop 2019, Belgium

[SCK-CEN, Mol, Belgium Nov 6-8, 2019](#)

6th International ADS&ThU Workshop Oct 2021, Yorktown, VA, USA

Economic Development Authority, County of York, VA, ISOHIM and IAEA are the sponsors

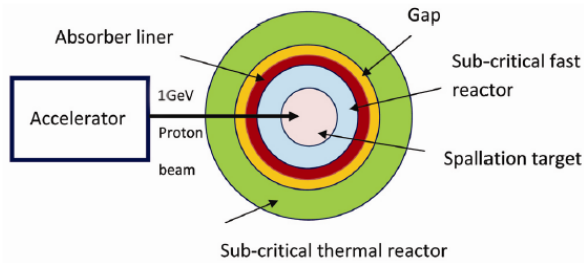
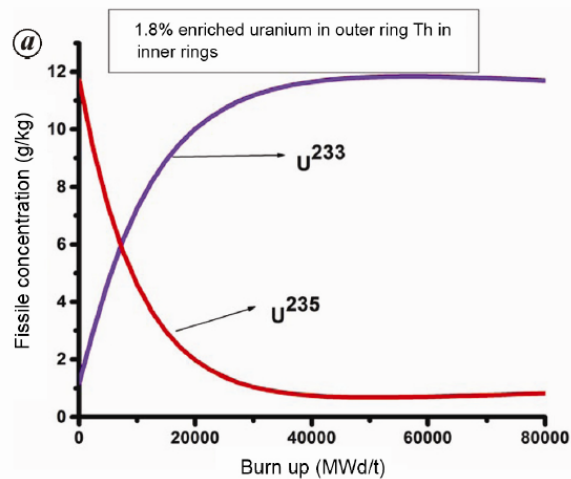

Figure 15. One-way coupled accelerator driven sub-critical system.



Natural uranium or slightly enriched (1.6%) is the Start up fuel for each plant and U^{233} will be bred and used for for ever closing the fuel cycle

Electricity costs will be reduced considerably

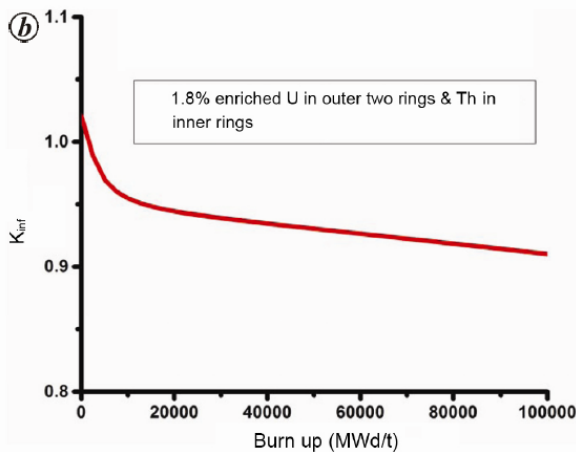

Figure 16. a, variation of fissile concentration with burn-up; b, Variation of k_{inf} with burn-up.

Dr. Srikumar Banerjee et al

CURRENT SCIENCE, VOL. 111, NO. 10, 25
NOVEMBER 2016

Dr. Srikumar Banerjee et al

CURRENT SCIENCE, VOL. 111, NO. 10, 25
NOVEMBER 2016

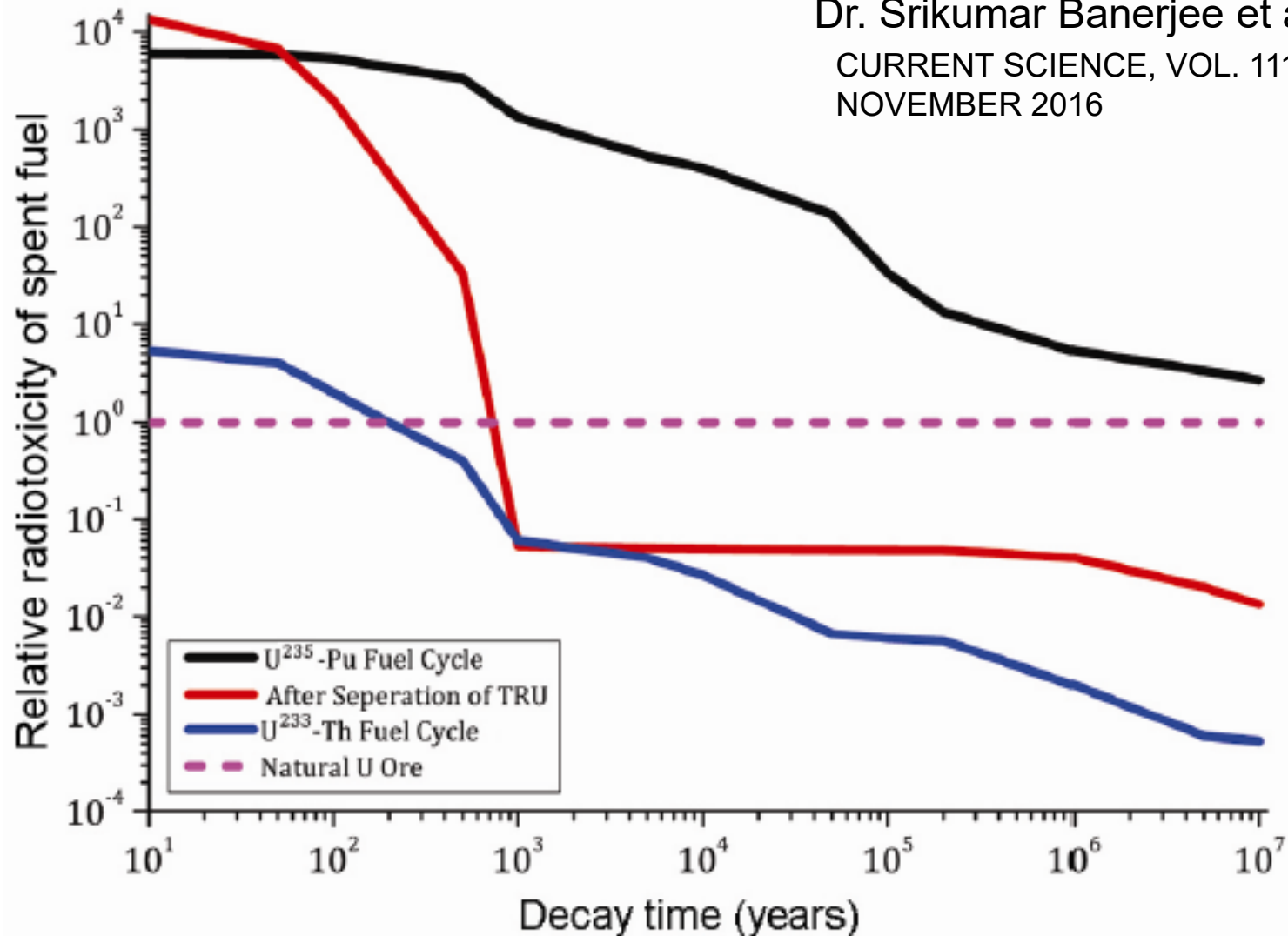
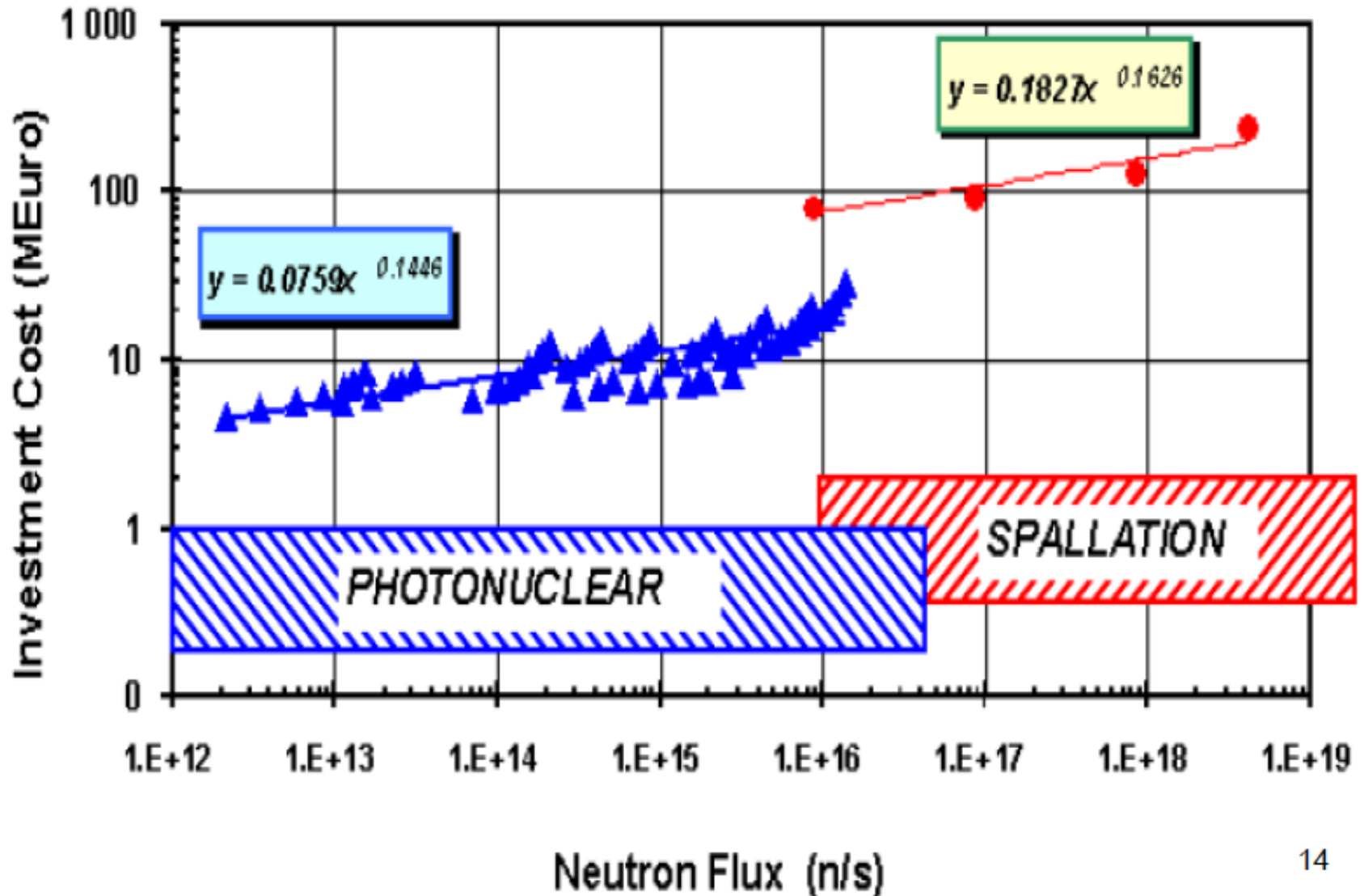

Figure 3. Relative radiotoxicity of nuclear waste in different fuel cycles as function of time.

Comparison Spallation / Photonuclear



Neutron yield comparison of 10 MeV vs 100 MeV electron beam of equal power

S. NO	Neutron Yield n/s in 4π solid angle for 1 Ampere $\times 10^{15}$						Neutron Yield n/s ($\times 10^{15}$) at 100 MeV for W/Ta for Equal Beam Power
		Be	D ₂ O	LiD	CD ₄ (liquid) /BeD ₂	W/Ta	
1	8 MeV	2.1	4.4	7.5	11.5	-	-
2	10MeV	5.5	9.3	12.5	15.0	1	20
3	15MeV	10.2	14.0	22.3	34.3	3.5	30
4	20MeV	14.9	20.0	28.6	44.8	20	40

K.C. Mittal et al 5th ADS&ThU Intl Workshop, SCK-CEN, Belgium, 2019

VT is planning to carryout neutron generation experiments with JLab LERF Injector

Neutron/gamma source for isotope developments

Neutrons – emitted in all directions: approximately isotropically

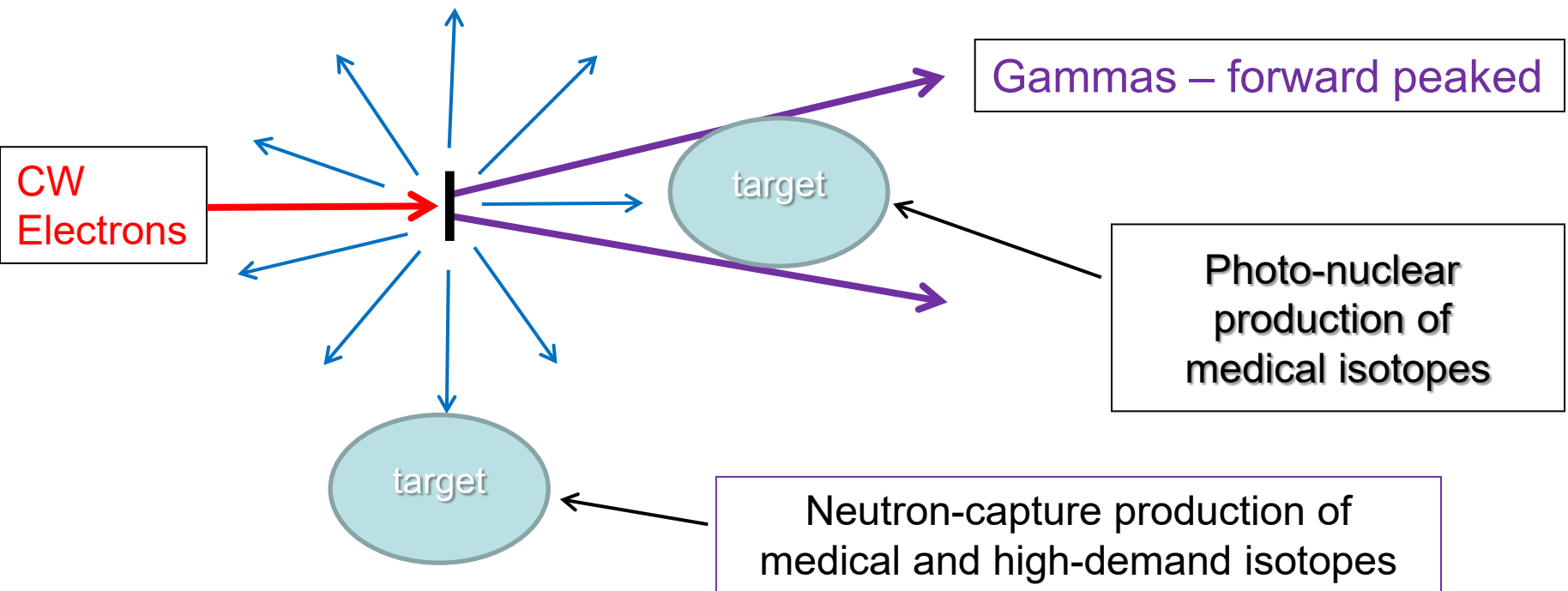

A 100 kW, 100 MeV electron linac is capable of producing 100% of the U.S. demand for many high-priority research isotopes for medical, industrial and other kinds of research. Such a device could also produce nearly 10% of the entire U.S. demand for ^{99}Mo .

ASMR's Unique Aspects

- Divorce from minor actinides by disassociating with ^{235}U & ^{238}U
- Reduce/remove concerns regarding nuclear proliferation & low waste
- Serve as backup generators to renewables
- Usher in much needed Hydrogen Economy
- Serve as high temperature heat sources for industrial processes
- Highly economical, ultra clean, super safe and distributed source

Declining Coal - Enthroning Nuclear - Fizzling out Gas -
Enabling Renewables – Pathway to Zero Carbon

We propose to build an Advanced Subcritical MSR ^{233}U & ^{232}Th breeder-burner in equilibrium Micro-Reactor (ASMR) R&D Center under a PPP in Yorktown,

These micro-reactor's linacs have dual use for the production of ^{225}Ac Actinium for medical applications